

SIZE: H 160 x W 800 x D 480mm

TAP HOLE(S): One

BASIN MATERIAL: Resin

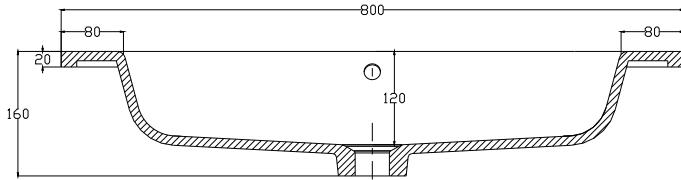

SECTION B-B

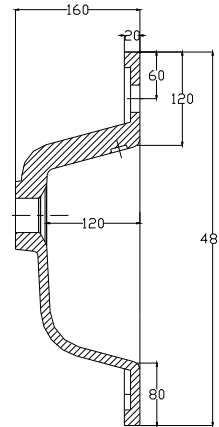
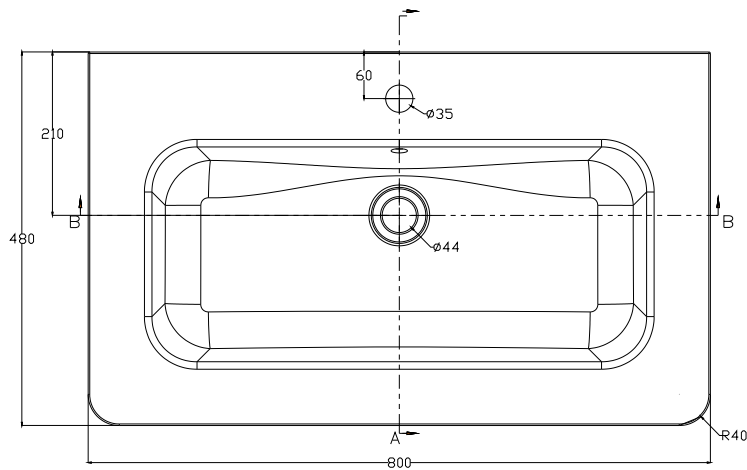
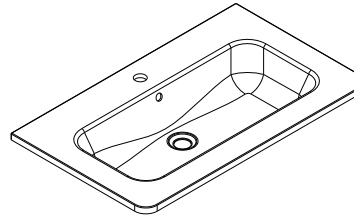

The information contained on this page was correct at date of issue. Fitting dimensions are provided as a guide only. Some variation may occur due to manufacturing tolerances. We pursue a policy of continuing improvement in design and performance of our products and so reserve the right to change specifications without prior notice.