

Carne 1700 x 700mm Single Ended Bath
Size: L 1700 x W 700 x H 370mm
Can Be Drilled For Tap Holes

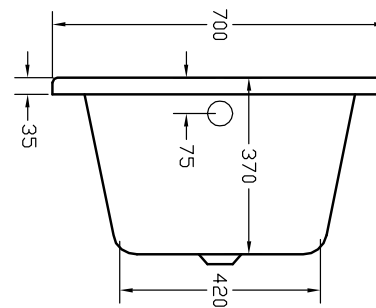
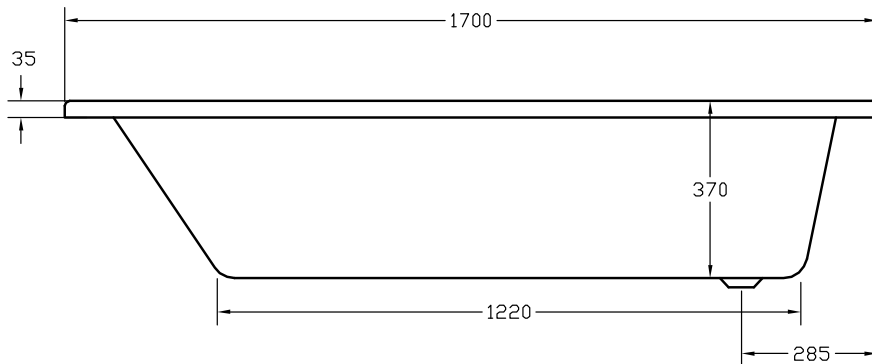

The information contained on this page was correct at date of issue. Fitting dimensions are provided as a guide only. Some variation may occur due to manufacturing tolerances. We pursue a policy of continuing improvement in design and performance of our products and so reserve the right to change specifications without prior notice.